















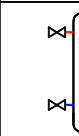



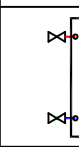







## Hidrolik Devre Eleman Tanımları

1b	Isıtma Cihazı	23	Flex Bağlantı
2	Isıtma Cihazı Pompası/Pompa Grubu	24	Genleşme Tankı
3	Isı Pompası	24a	Hiyenik Genleşme Tankı (Şebeke)
4	Cihaz Montaj Seti	25	Emniyet Ventili
5	Takviye Isıtıcı	26	Çekvalf
6	Hidrolik Ünite	27	Vana
7	Boyeler	28	Filtre
7a	Çift Serpantinli Boyler	29	Basınç Düşürücü
7b	Isı Pompası Boyleri	30	Doldurma-Boşaltma Vanası
7c	Çift Serpantinli Isı Pompası Boyleri	31	Termostatik Vana
8	Akümülyasyon (Buffer) Tank	32	Bypass Vanası
9	Sistem Regleri	33	Debi Ayar Vanası
9a	Regler	34	Balans Vanası
9b	Uzaktan Kumanda Modülü	35	Kilitli Vana
9c	Dış Hava Duyargası	36	Hava Atma Valfi
9d	Karıştırıcı Modül	37	Manometre
10	eBUS Arayüzü	38	Havuz Termostatı (On-Off 24 V çıkışlı)
11	Hidrolik Tank	39a	3 Yollu Motorlu Vana On/Off
12	Sistem Ayırma Modülü	39b	3 Yollu Motorlu Vana Karıştırıcı
13	Sıcak Kullanım Suyu Modülü	40	2 Yollu Motorlu Vana
14	Solar Pompa Modülü	41	Dış Hava Sensörü
15	Solar Pompa İstasyonu	42	Sigorta
16	Drainback Depolu Pompa Modülü	43	Kontaktör
17	Solar Kolektör	44	Limit Termostat
18	Plakalı Eşanjör	45	Sirkülasyon Pompası
19	Hidrolik Karıştırıcı / Denge Tankı	46	Boyeler Isıtma Pompası
20	Tortu Tutucu	47	Nötralizasyon Tankı
21	Manyetik Filtre	48	Yüzme Havuzu Pompası
22	Hava Ayırıştırıcı	49	Harici Havuz Kontrol Ünitesi
		50	Flex Boru







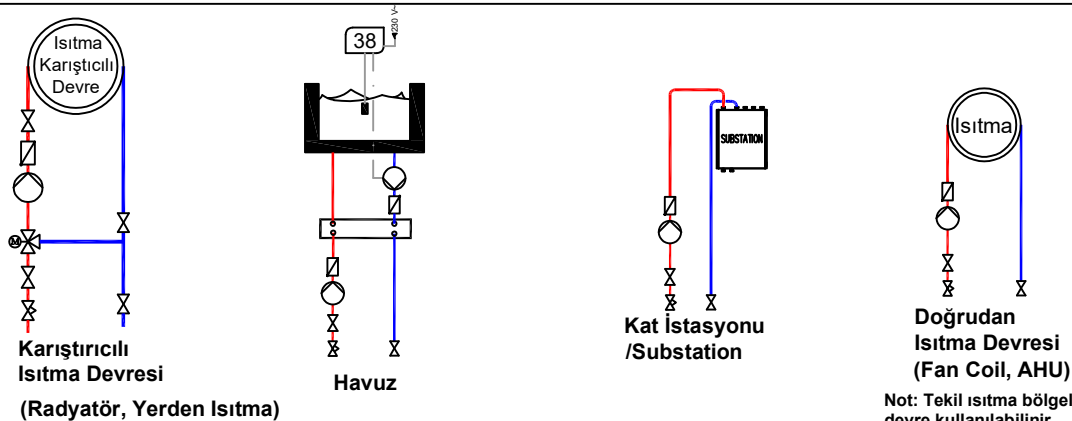

## Semboller

	<b>Hava Ayırıştırıcı</b>		<b>Debi Ayar Vanası</b>		<b>Dış Hava duyargası</b>		<b>Sensör</b>
	<b>Tortu Tutucu</b>		<b>Kilitli Vana</b>		<b>Hidrolik Karıştırıcı</b>		<b>Kontaktör</b>
	<b>Manyetik Filtre</b>		<b>Emniyet Ventili</b>		<b>Plakalı Eşanjör</b>		<b>Motorlu Üç Yollu Vana</b>
			<b>Termometre</b>				<b>Motorlu İki Yollu Vana</b>
			<b>Manometre</b>				<b>Termostatik Vana</b>
			<b>Basınç Düşürücü</b>				<b>Sigorta 6-10 A</b>
			<b>Hava Atma Valfi</b>				<b>Çekvalf</b>
			<b>Doldurma-Boşaltma Vanası</b>				<b>Pompa</b>
			<b>Vana</b>				<b>Genleşme Tankı</b>
			<b>Filtre</b>				
			<b>Balans Vanası</b>				
			<b>Bypass Vanası</b>				

## Isıtma Bölgeleri



## Boru ve Kablo Tanımları

<b>Gidiş Hattı</b>		<b>Glikol Gidiş</b>		<b>Resirkülasyon</b>		<b>Yoğuşma hattı</b>	
<b>Dönüş Hattı</b>		<b>Glikol Dönüş</b>		<b>eBUS</b>	 2 (bus)	<b>Elektrik hattı ve kablo damarı</b>	 3